

SP18A SP18A-J



For unsurpassed outreach and flexibility, choose Aichi SP18A / SP18A-J aerial platform from Aichi Skymaster.

- Max. Platform Height: 18.2m
- Max. Load Capacity: 227kgs

New HV Control System as STD.

Operator can easily maneuver the Aichi SP18A / SP18A-J by HV control system. Both the SP18A and SP18A-J are equipped with horizontal and vertical movement control(HV control) as standard which permits the operator to move the basket straight in a vertical and horizontal direction at the same time with a single lever operation.

16.7m Horizontal Outreach(SP18A)

15.8m Horizontal Outreach(SP18A-J)

Aichi SP18A/SP18A-J aerial platform has the greatest outreach in its class.

Smoother / Safer

Aichi's improved computer system provides for smoother and safer operation. On the job site, operator is supported and protected by "Travel speed control", "Rotation speed control", "Lifting speed control" at all time.

Sandblast Protection

The hydraulic pipe and electric cables are installed inside the boom to prevent damages due to accidental collision and sandblasting. Also the top end of the boom is equipped with improved dustproof sweeper.



Specifications	SP18A-J	SP18A
Reach Specifications		
Platform Height	18.2m	
Horizontal Outreach	15.8m	16.7m
Swing	360degree,Continuous	
Platform Capacity	227kgs	
Platform Rotator	180degree(90,90)	
Jib Range of Articulation	130degree(+70,-60)	N/A
Dimension Data		
A. Platform Size	1.8m x 0.75m(Std), 2.4m x 0.75m(Opt)	
B. Overall Width	2.43m	
C. Tailswing	2.36m	
D. Overall Height	2.64m	
E. Overall Length	10.04m	9.17m
F. Wheelbase	2.50m	
G. Ground Clearance	0.255m	
Gross Vehicle Weight	12,100kgs	12,100kgs
Chassis		
Drive Speed 4WD	5.5km/h	
Gradeability 4WD	24degree	
Tires	15 x 19.5,Foamfilled	
Axle Oscillation	STD.	
Power Source		
Diesel Engine	Isuzu A 4JB1,PAA-22 44.3KW/2,400rpm	
Fuel Tank Capacity	150liter	
Safety Features		
H-V Control	STD	
Sandblast Protection	STD	
Travel Speed Control	STD	
Rotation Speed Control	STD	
Lifting Speed Control	STD	
All Motion Alarm	STD	
Lever Guard	STD	

*These specifications and appearance are subject to change for improvement without notice.

AICHI CORPORATION

International Division

1152,Ryoke,Ageo,Saitama 362-8550,Japan

Tel:+81-48-781-1671 Fax:+81-48-781-1808

E-mail:aichi@tky.3web.ne.jp

< Distributor >

SP18A-J

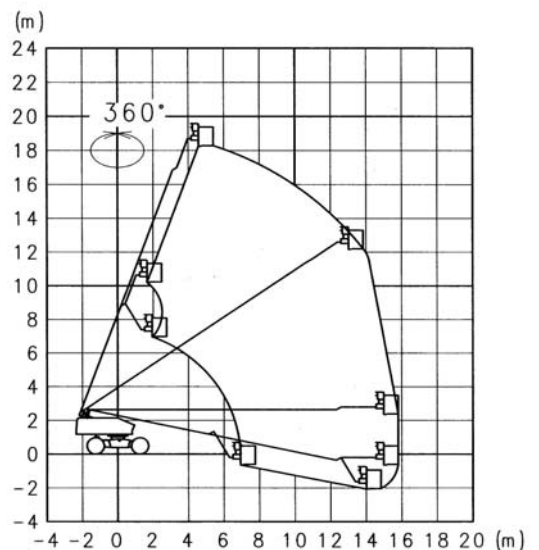
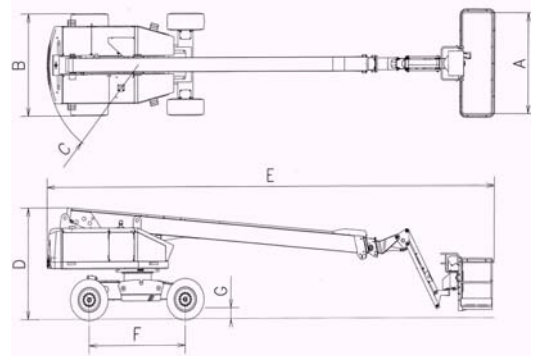

SP18A

